

RC OFF-ROAD MONSTER TRUCK SERIES

MONSTER  
TRUCK2.4GHz  
VersionAGES 14+  
适用于年龄14岁以上

长度	560毫米	Length	460mm (18.11 Inches)
前轮距	345毫米	Front Track	280mm (11.02 Inches)
后轮距	345毫米	Rear Track	330mm (12.99 Inches)
轴距	335毫米	Wheelbase	95mm (3.74 Inches)
轮胎	直径130毫米 宽70毫米	Tire	Diameter, 5.11 Inches (130mm) Width, 2.75 Inches(70mm)

- \* 全车采用双差速粉末金属伞齿轮+CNC轴；
- \* 高性能模型滚动轴承；
- \* 超强抓地力、超耐磨橡胶轮胎；
- \* 全车采用高性能超强抗冲击复合尼龙工程塑胶材料；
- \* 采用模型专用高放电镍氢、锂电池；
- \* 采用模型专用无刷马达；
- \* 采用高反应、大功率无刷电子调速器；
- \* 4支油压阻尼避震；
- \* 前后4个一体化避震护罩；
- \* 采用金属可调节摩擦器；
- \* 采用金属前后主传动轴连接器。

- \* Twin Differential Sintered Hardened Steel Bevel Gears With CNC.
- \* Axis High-speed Ball Bearings.
- \* Great grip and super wear-resisting rubber tires.
- \* High Performance Ultra Rugged Composite Nylon Materials.
- \* Advanced High Discharge, High Capacity And High Power NiMH & LI-PO Battery Technology.
- \* Professional Hobby Brushless Motor.
- \* Ultra-Smooth, High-Frequency Operation And High-Power Handling Capability Brushless Esc.
- \* 4 x Oil-Filled Damp Shocks.
- \* Ago Rear Integrated Shock Guards.
- \* Adjustable Alloy Slipper Clutch.
- \* Front and Rear hardened steel Center Driveshaft hub.

# Addition Accessories 配送工具

# Tools Recommended 推荐工具

Hex Wrench 六角扳钳

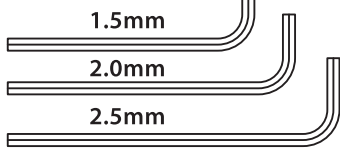

Small Cross Tool 小十字套筒

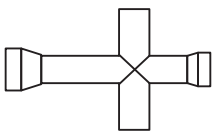

Wrench (small) 扳手 (小的)

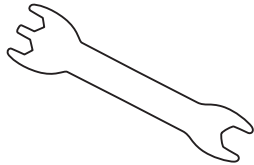

Hex screwdrivers 内六角螺丝刀

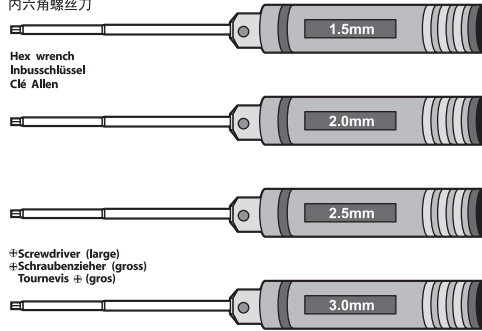

Hex wrench Inbusschlüssel Clé Allen

#Screwdriver (large) #Schraubenzieher (gross) Tournevis # (gros)

Modeling knife Modelliermesser Couteau de modéliste 刮刀

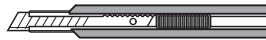

Side cutter Seitenschneider Pincès coupantes 剪钳



Curved scissors Schere Ciseaux 剪刀

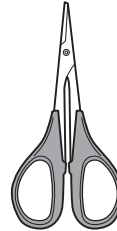

Long nose pliers Flachzange Pincès à becs longs 尖嘴钳

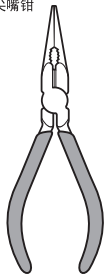

Model Glue 模型胶水

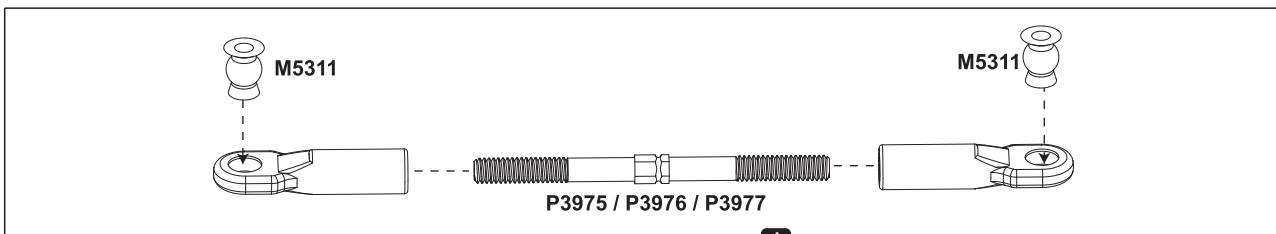
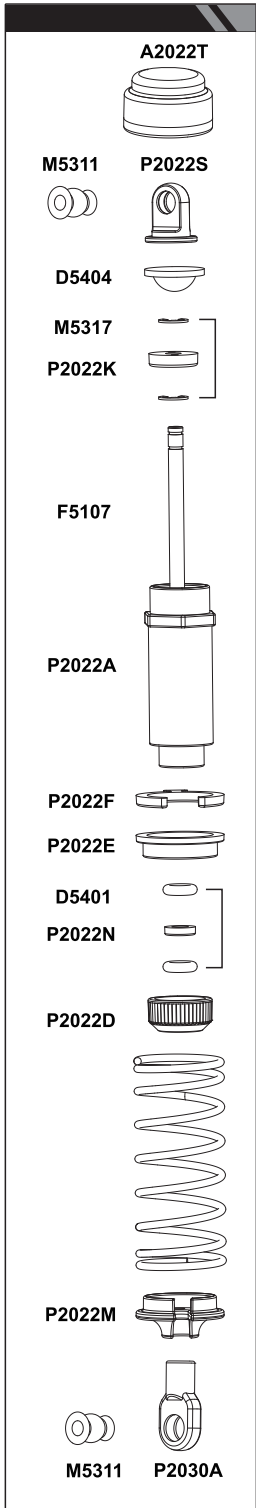
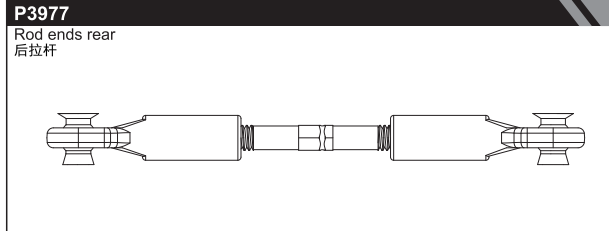
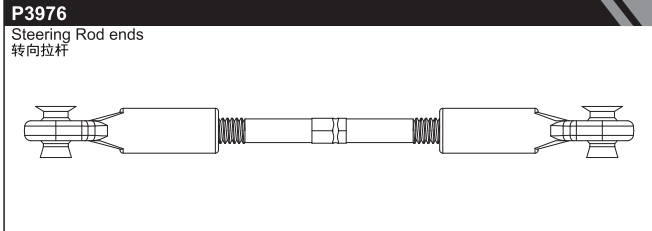
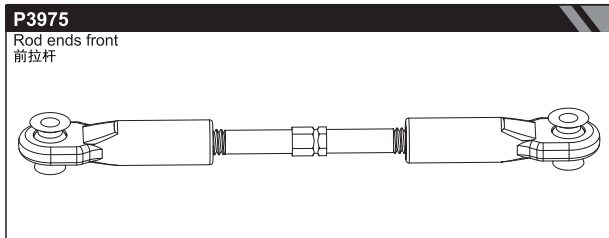
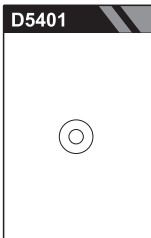
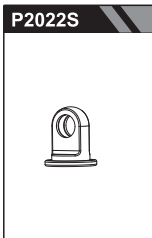
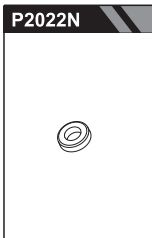
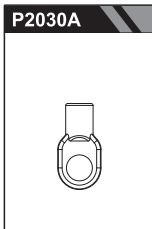
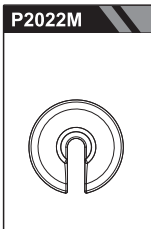
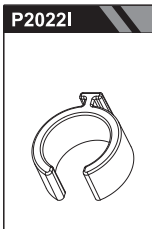
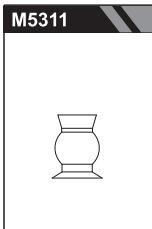
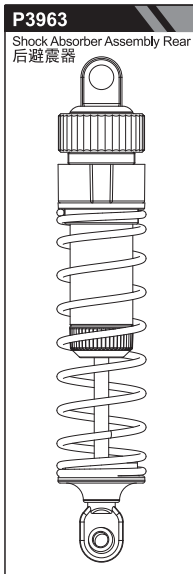
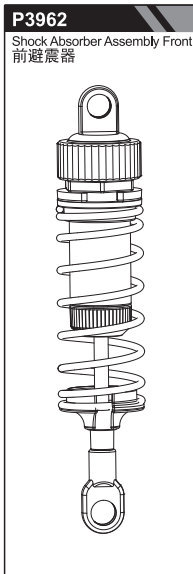
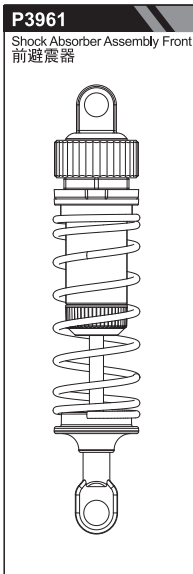
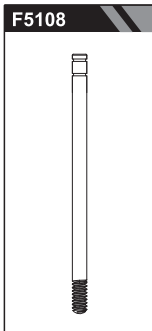
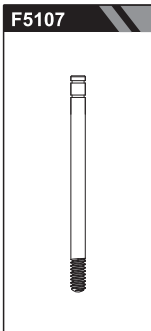
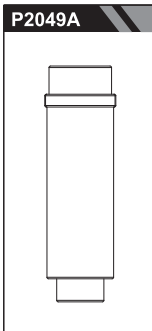
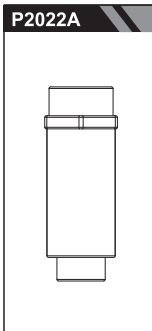
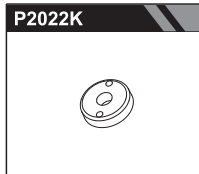
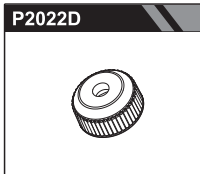
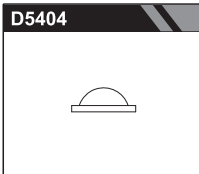
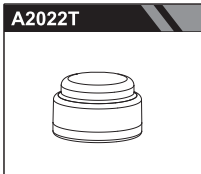

## Front/Rear Differential Gear Assembly 前后差速器总成

**G4313** bevel gear 13T  
伞齿轮 x4

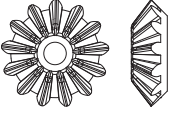

**B5504** 8x16x5mm  
Ball bearings  
滚动轴承 x2



**B5505** 10x15x4mm  
Ball bearings  
滚动轴承 x2

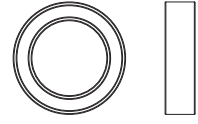

**P2014** Differential Carrier  
差速壳 x2

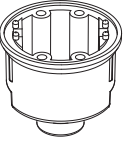

**D5403** 22.5x24mm  
Rubber  
橡胶垫 x2

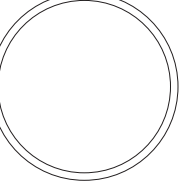

**G4837** 37T bevel gear  
伞齿轮 x2

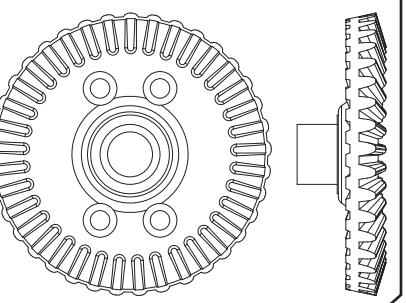

**G4413** bevel gear 13T  
伞齿轮 x4

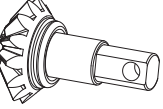

**F5216** M2.5x8mm  
hex socket cap-head  
内六角杯头螺丝 x8



**M5302** 3x20mm  
Axle pins  
轴销 x2

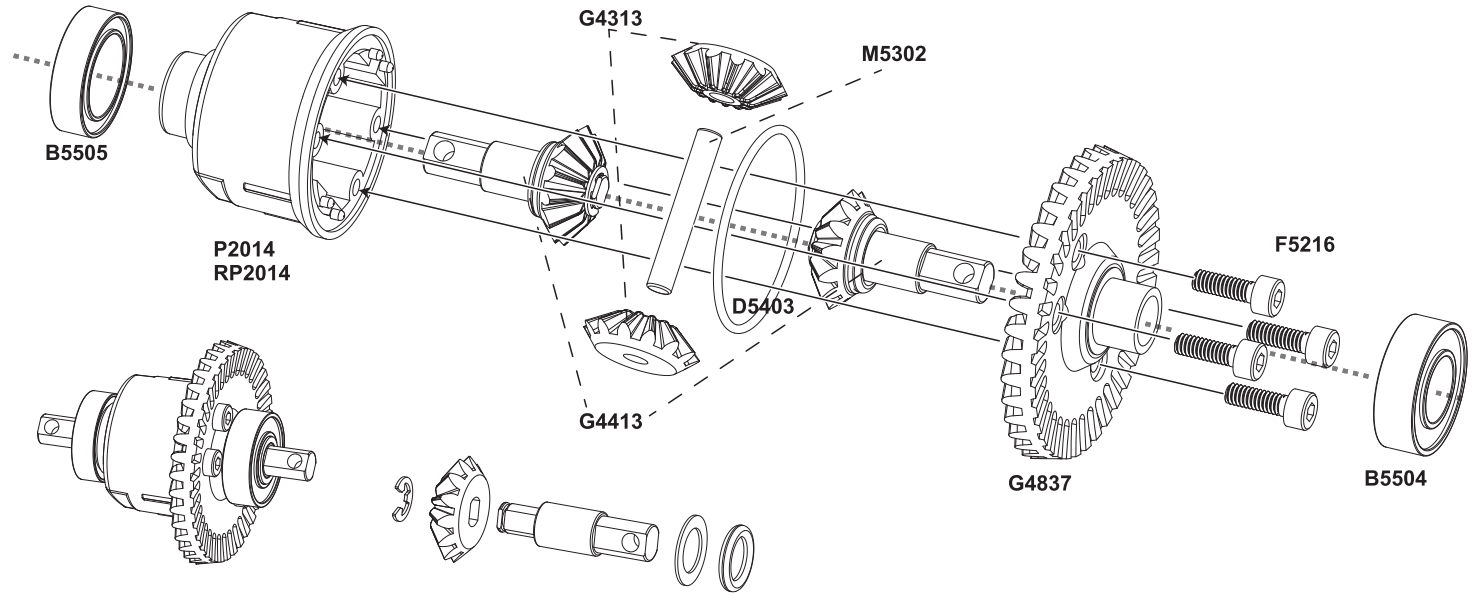
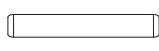

## Throttle Gear with Slipper Clutch System Assembly 减速齿轮和磨擦离合器系统总成

**F5218** M3x8mm  
hex socket cap-head  
内六角杯头螺丝 x3

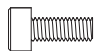

**F5223** M3x2.5x10mm  
Screws  
内六角螺丝 x1



**M5301** 2x10mm  
Axle pins  
轴销 x1



**B5502** 5x11x4mm  
Ball bearings  
滚动轴承 x1



**B5505** 10x15x4mm  
Ball bearings  
滚动轴承 x1

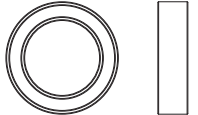

**G1854** Spur gear 54T  
主从动齿轮 x1

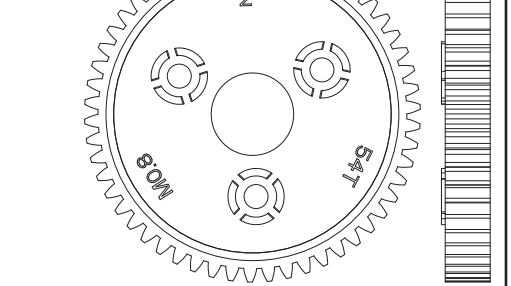

**M5313** 9x10mm  
lipper clutch spring  
摩擦片弹簧 x1

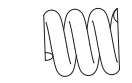

**F5227** M5  
Mylon locking  
防松螺母 x1



**P2039** Slipper pressure plate  
摩擦片座 x2

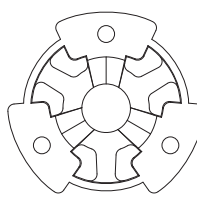

**D5405** Slipper clutch  
摩擦片 x2

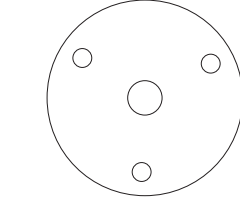

**P2037** Drive hub center rear  
后传动接头 x1

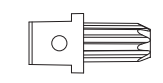

**P2038** Bearing adapter  
轴承垫 x1



**F5106** 5x59mm  
Drive shaft  
磨擦轴 x1

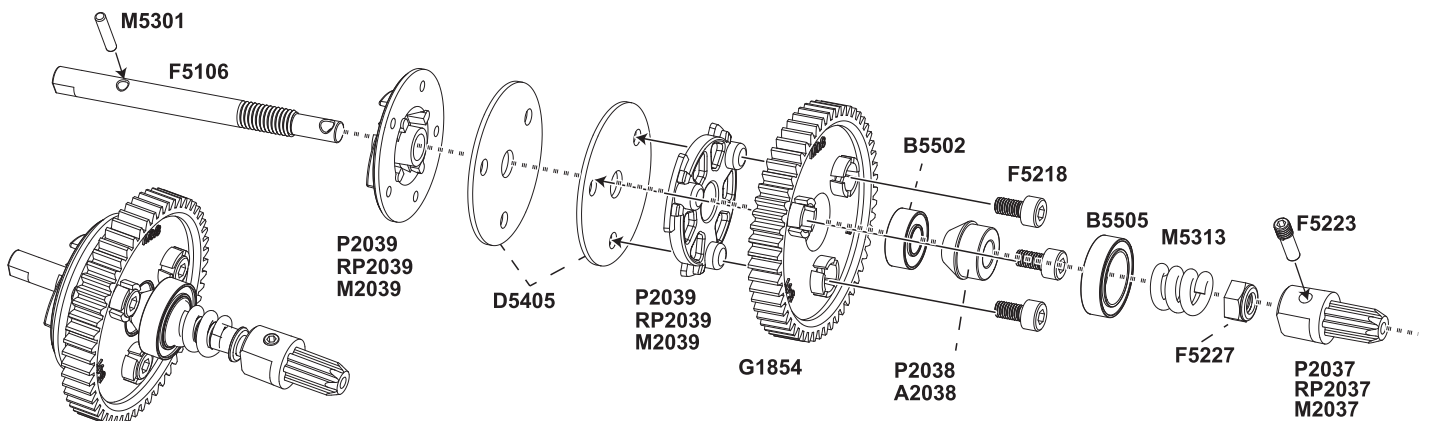
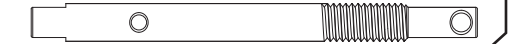

## Front Differential Gear Box Assembly 前差速箱总成

**F5223** M3x2.5x10mm  
Screws  
内六角螺丝 x1



**F5204** M3x10mm  
hex socket button head  
内六角半圆头螺丝 x2



**F5206** M3x15mm  
hex socket button head  
内六角半圆头螺丝 x2



**P2013**  
Housings differential front  
前差速箱壳 x2

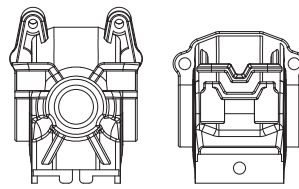

**P2023**  
Shock tower front  
前减震器座 x1

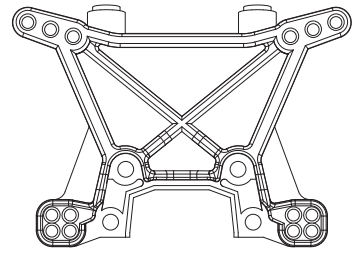

**G4513** x1

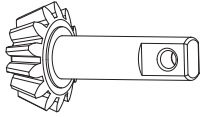

**P2028**  
Drive hub center front  
前传动接头 x1

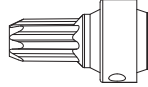

**B5503** 6x12x4mm  
Ball bearings  
滚动轴承 x2



**F5223**

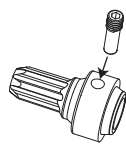

**P2028**  
**RP2028**  
**A2028**

**M5317**  
E2.5

**G4513** 13T

**M5319** 6x27mm

**B5503**

**P2023**

**G4513**

**F5204**

**F5206**

**P2013**

## Rear Differential Gear Box Assembly 后差速箱总成

**F5204** M3x10mm  
hex socket button head  
内六角半圆头螺丝 x2



**F5206** M3x15mm  
hex socket button head  
内六角半圆头螺丝 x2



**B5506** 12x18x4mm  
Ball bearings  
滚动轴承 x1

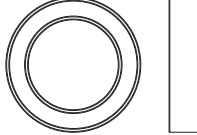

**G47 13**  
bevel gear 13T  
伞齿轮 x1

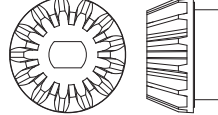

**P2041**  
Housings differential rear  
后差速箱壳 x2

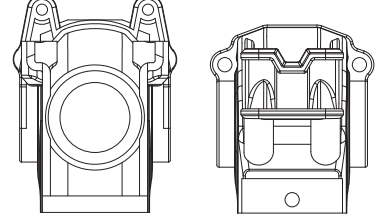

**P2042**  
Shock tower rear  
后减震器座 x1

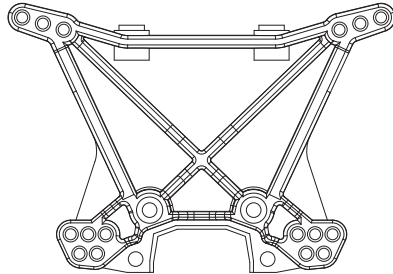

**P2042**

**F5204**

**B5506**

**G4713**

**F5206**

**P2041**

# Servo Saver/Steering Assembly 转向缓冲总成

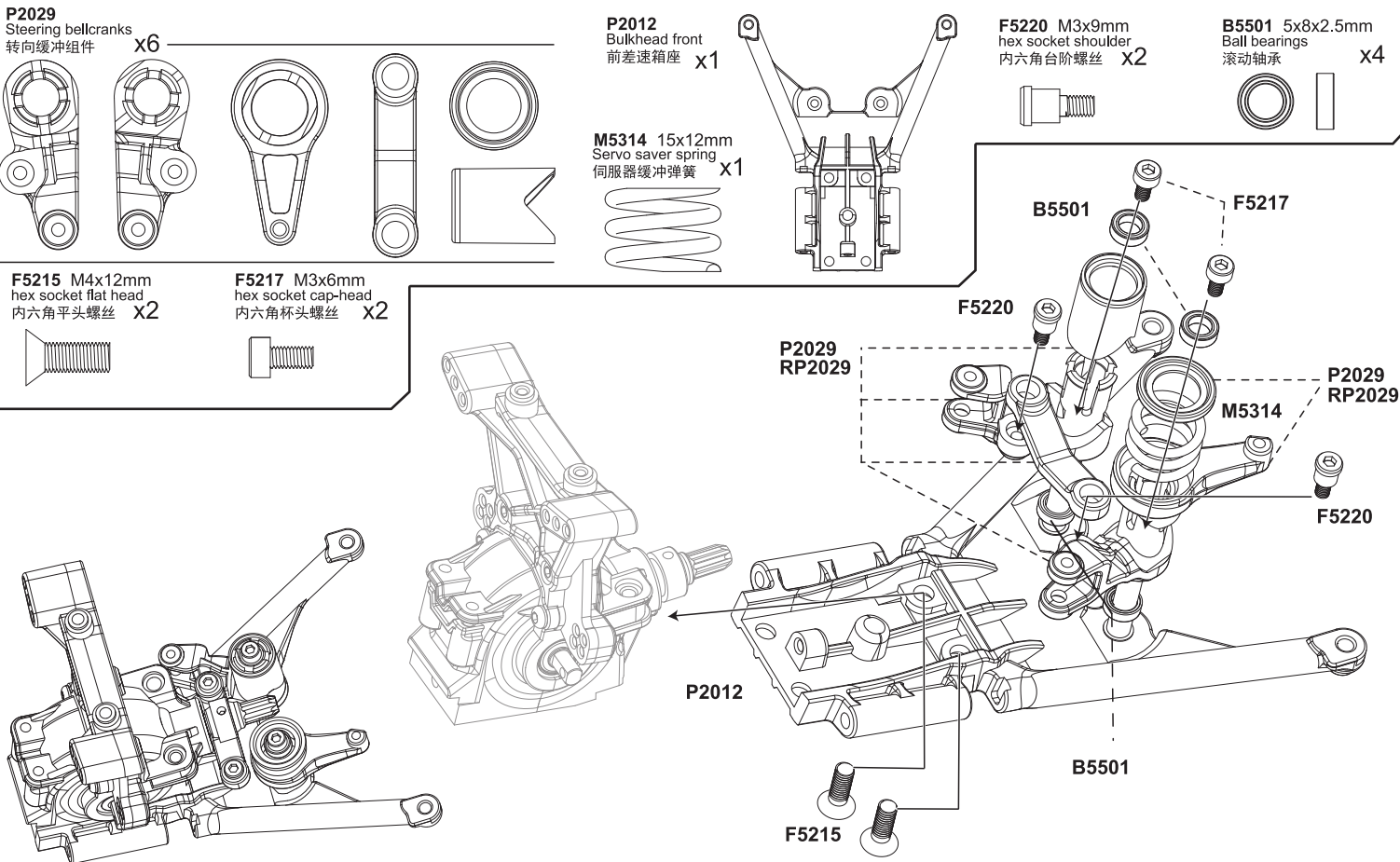

## (1) Front Rear Universal Coupling Drive Joint 前后万向联轴器总成 (2) Steering Hubs Assembly 转向杯总成

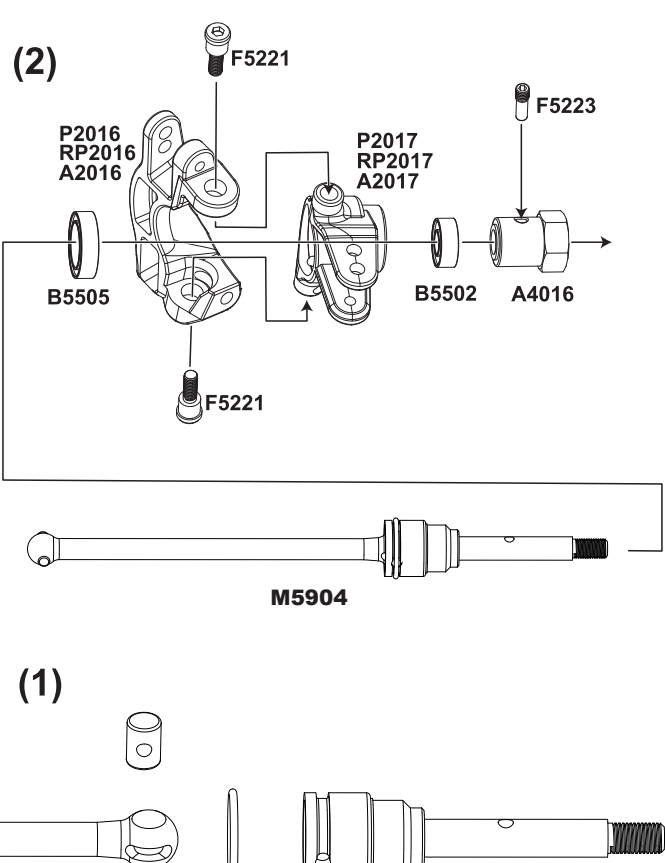
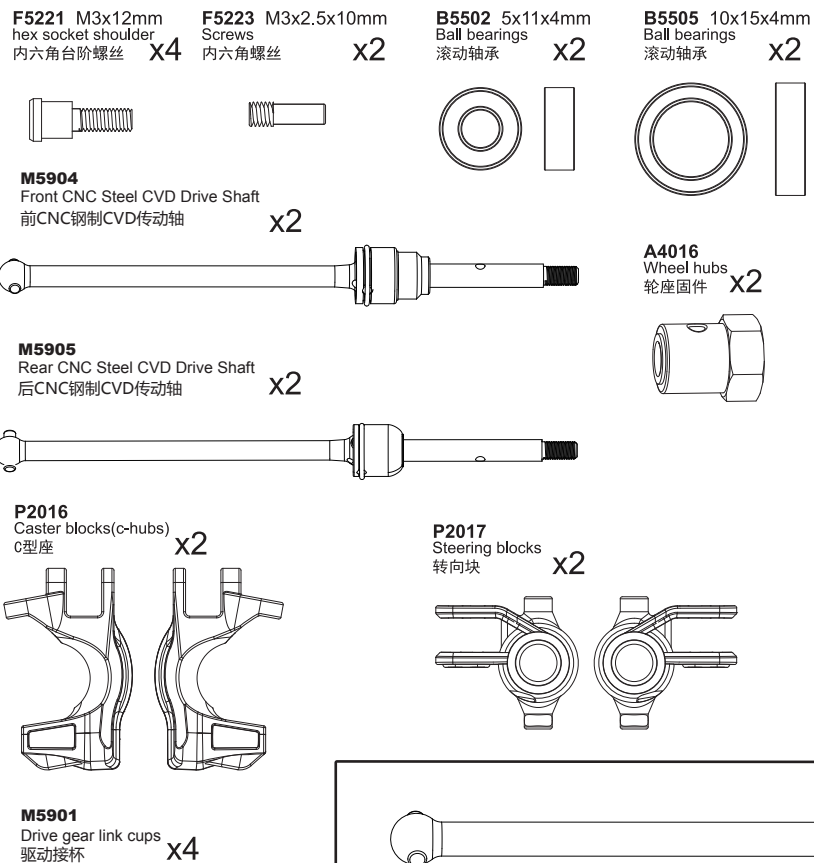

(1) Front/Rear Body brace Assembly 前后车壳支架

(2) Servo Arm/Steering Arm Assembly 伺服器摇臂拉杆

**P2026** Body mount body post  
车身壳架立柱 x4

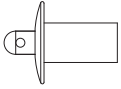

**F5204** M3x10mm hex socket button head  
内六角半圆头螺丝 x4

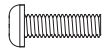

**F5206** M3x15mm hex socket button head  
内六角半圆头螺丝 x1



**P2031** Servo Arm  
伺服器臂 x1

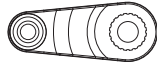

**P2030** Linkage steering  
伺服器拉杆 x1

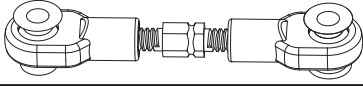

**P2025** Body mount  
车身壳架 x2

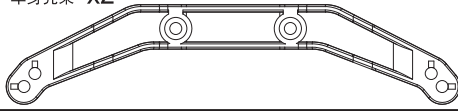

(2)

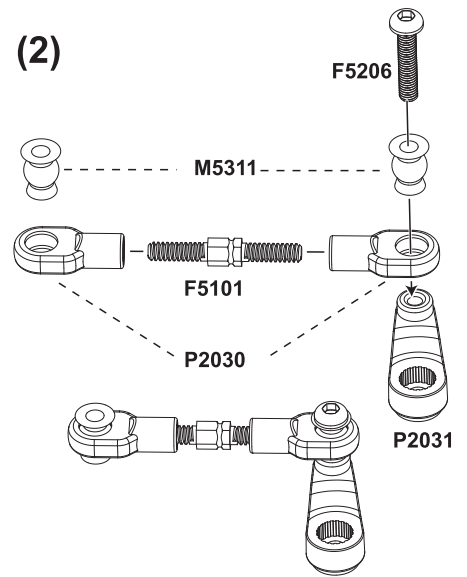

(1)

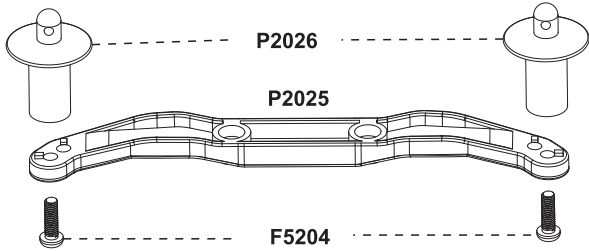

Front Unit Complete 前部份总成

**F5223** M3x2.5x10mm  
Screws  
内六角螺丝 x2



**F5204** M3x10mm  
hex socket button head  
内六角半圆头螺丝 x4



**F5206** M3x15mm  
hex socket button head  
内六角半圆头螺丝 x11



**F5231** M3x18mm  
hex socket button head  
内六角半圆头螺丝 x4



**F5213** M3x14mm  
hex socket flat head  
内六角平头螺丝 x2



**F5214** M4x10mm  
hex socket flat head  
内六角平头螺丝 x1



**F5215** M4x12mm  
hex socket flat head  
内六角平头螺丝 x2



**F5208** M4x10mm  
hex socket button head  
内六角半圆头螺丝 x2



**P3975** Rod ends front  
前拉杆 x2

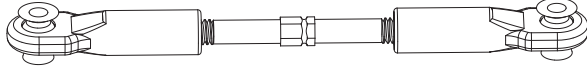

**P3976** Steering Rod ends  
转向拉杆 x2

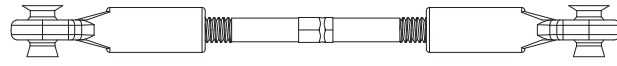

**F5221** M3x12mm  
hex socket shoulder  
内六角台阶螺丝 x2

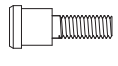

**P2057** Bumper front  
前保险杠 x2

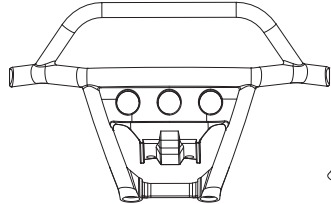

**P2015** Suspension arms  
摆臂 x2

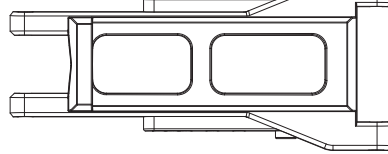

**P2051** Integrated Shock Guards  
避震护罩 x2

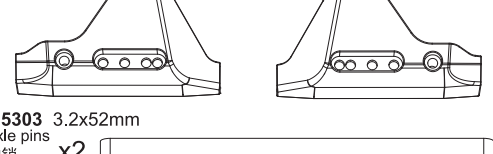

**M5303** 3.2x52mm  
Axle pins  
轴销 x2

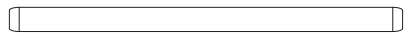

**A4001** 91x62mm  
Bulkhead tie bars front  
前摇臂杆铝片 x1

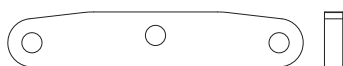

**P3962** Shock Absorber  
Assembly front  
前避震器



**P3961** Shock Absorber  
Assembly front  
前避震器



**F5224** Suspension pin set  
轮座轴紧固件 x2

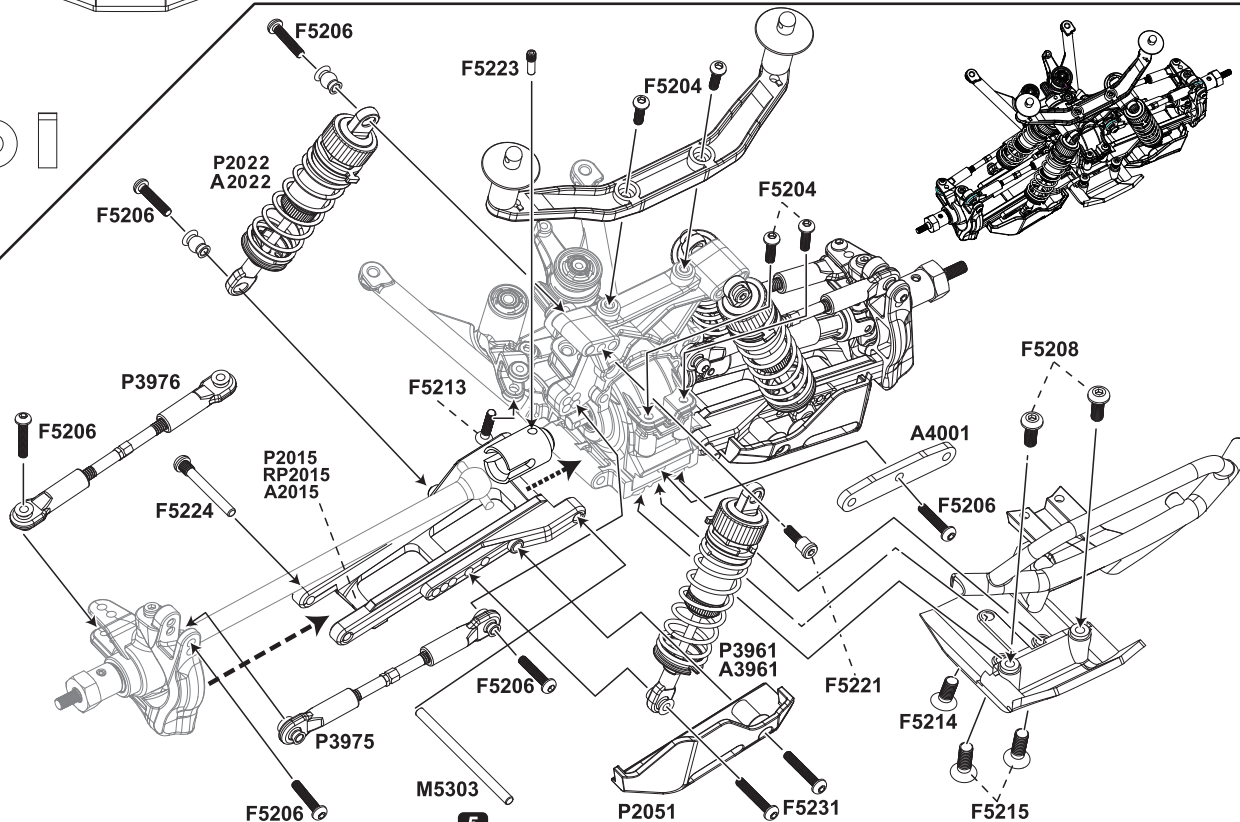
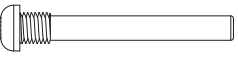



# Chassis System Assembly 底盘系统装配图

**F5203** M3x6mm  
hex socket button head  
内六角半圆头螺丝 X1

**F5204** M3x10mm  
hex socket button head  
内六角半圆头螺丝 X2

**F5230** M3x5mm  
hex socket flat head  
内六角平头螺丝 X1

**F5210** M3x8mm  
hex socket flat head  
内六角平头螺丝 X2

**F5222** M3x6mm  
hex socket flat head  
内六角大平头螺丝 X5

**P2036**  
Motor mount  
马达安装座 X1

**A4004**  
Center Driver Shaft  
合金主驱动轴 X1

**F5219** M3x14mm  
hex socket cap-head  
内六角杯头螺丝 X1

**F5225** M3  
Mylon locking  
防松螺母 X1

**P2032**  
Chassis Slash  
车底座 X1

**A4003**  
Plate motor  
马达固定片 X1

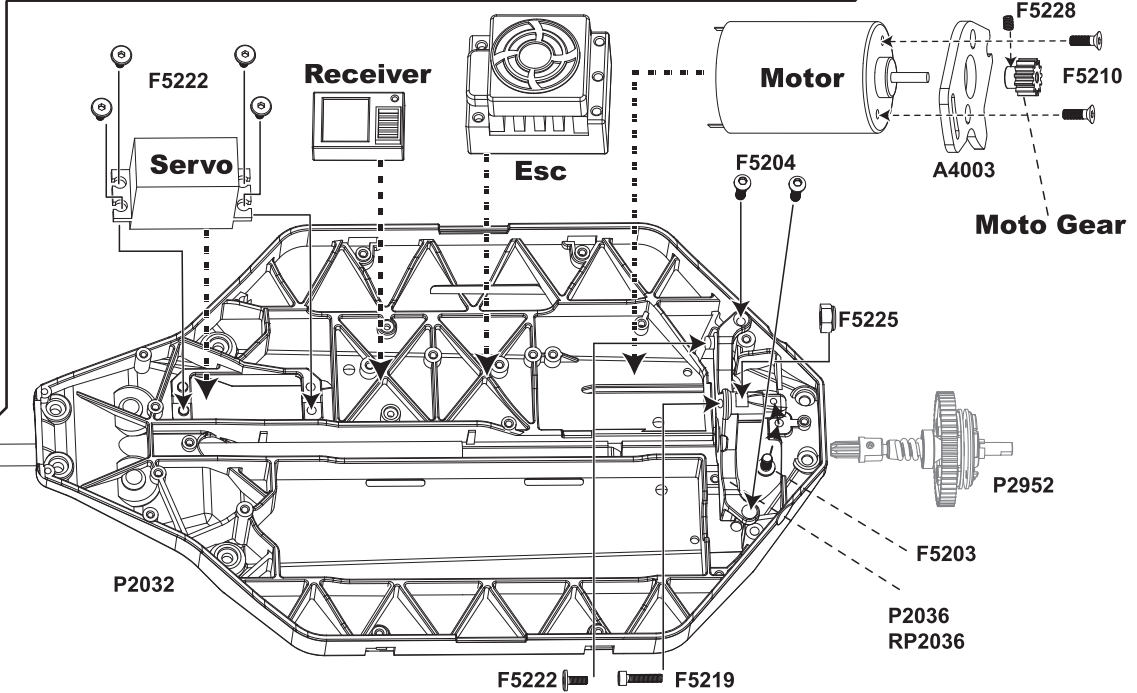
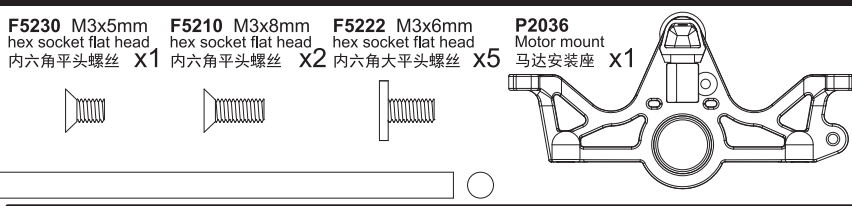
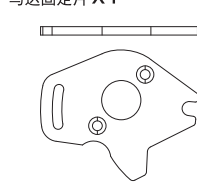

# Assembly View 总装配图

**F5203** M3x6mm  
hex socket button head  
内六角半圆头螺丝 X4

**F5208** M4x10mm  
hex socket button head  
内六角半圆头螺丝 X2

**F5209** M4x12mm  
hex socket button head  
内六角半圆头螺丝 X6

**F5226** M4  
Mylon locking  
防松螺母 X4

**P2035**  
Cover gear  
齿轮盖 X1

**P3978**  
Tires  
轮胎 X4

**P2033**  
Cover center driveshaft  
传动管盖 X1

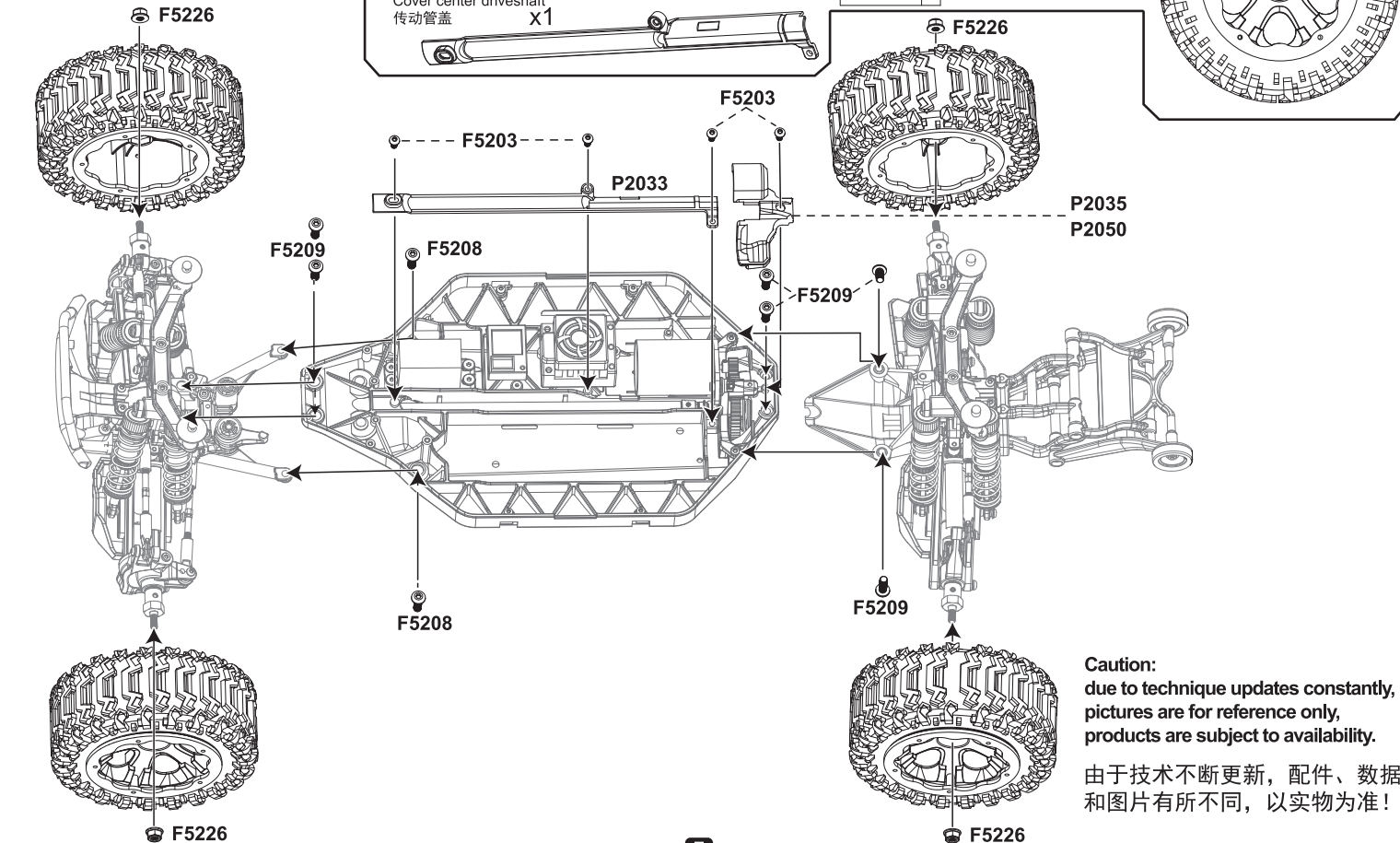

**Caution:**  
due to technique updates constantly,  
pictures are for reference only,  
products are subject to availability.

由于技术不断更新，配件、数据  
和图片有所不同，以实物为准！