



DON'T IMPROPERLY USE THIS PRODUCT

Don't willfully dismantle, modify or process it. For any modification and maintenance, please use the parts list in product content to ensure structure safety. Please operate products within specified limit, overload is forbidden, and illegal purposes in violation of safety order are forbidden too.

IMPORTANT NOTICES

Note! The products are manufactured by batches after performances have been strictly demonstrated and practically tested to verify meeting safety standards, but personnel below 8 are forbidden to use it. For any use of remote-controlled model, the manufacturer or dealer won't bear any responsibility for accidents resulted from abnormal parts usage and wearing, improper assembling or operation under unsafe environment. Please be sure to operate this product under safe environment. This company won't bear property loss and personal injury resulted from improper operation/dismantling/modification on sold product.

NO.1573

The Company has the right of final interpretation of this instruction manual statement.

MADE IN CHINA



USE MANUAL

8+ AGES

PROFESSIONAL R/C HOPPER TRUCK MODEL WITH 10 FUNCTIONS



Thank you for purchasing this R/C model manufactured by Guangdong Huina Model Co., Ltd. Please read the instruction completely to gain using method.

Operation of remote control

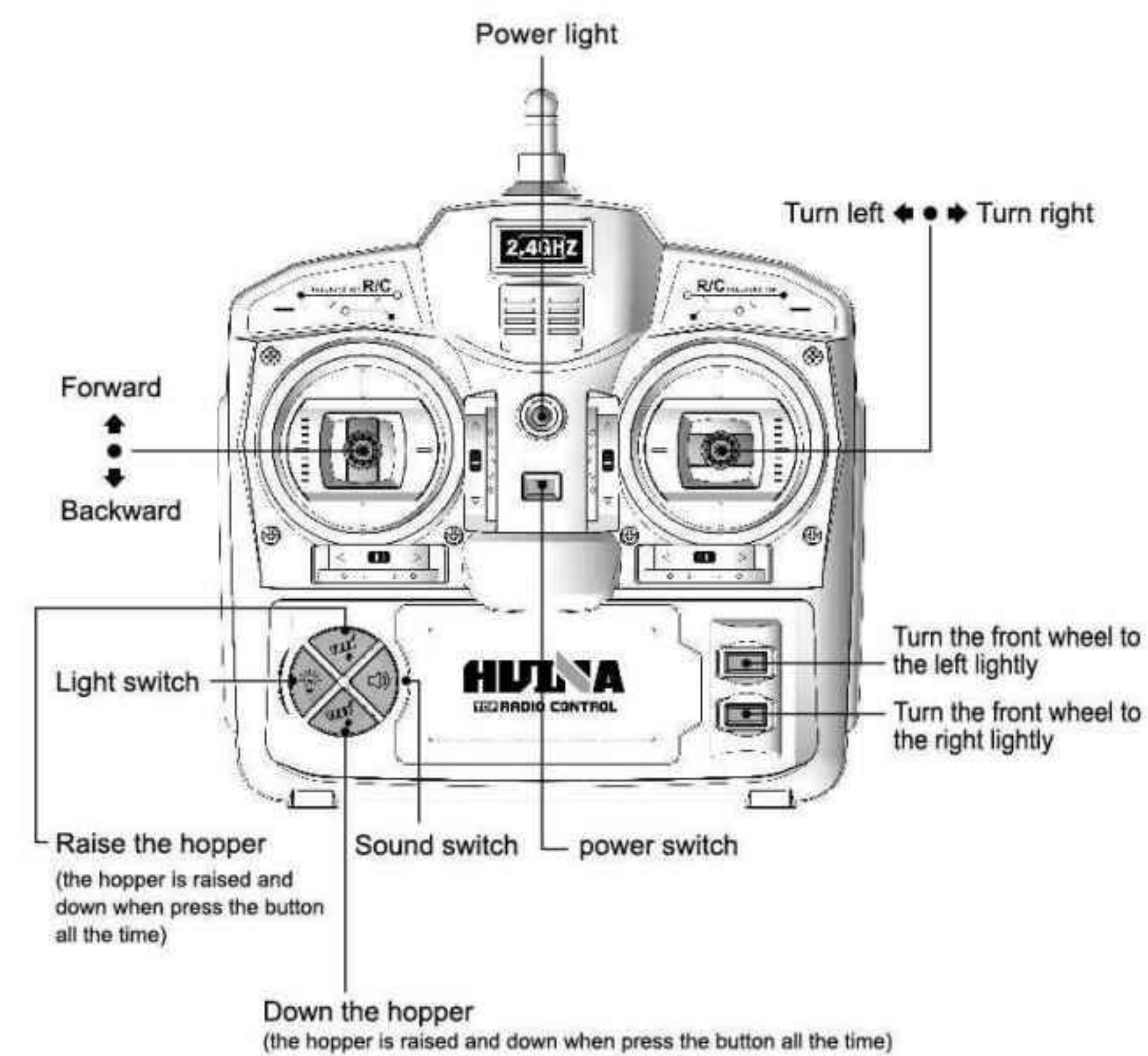

1 HUI NA MODEL

Operation of playing the truck

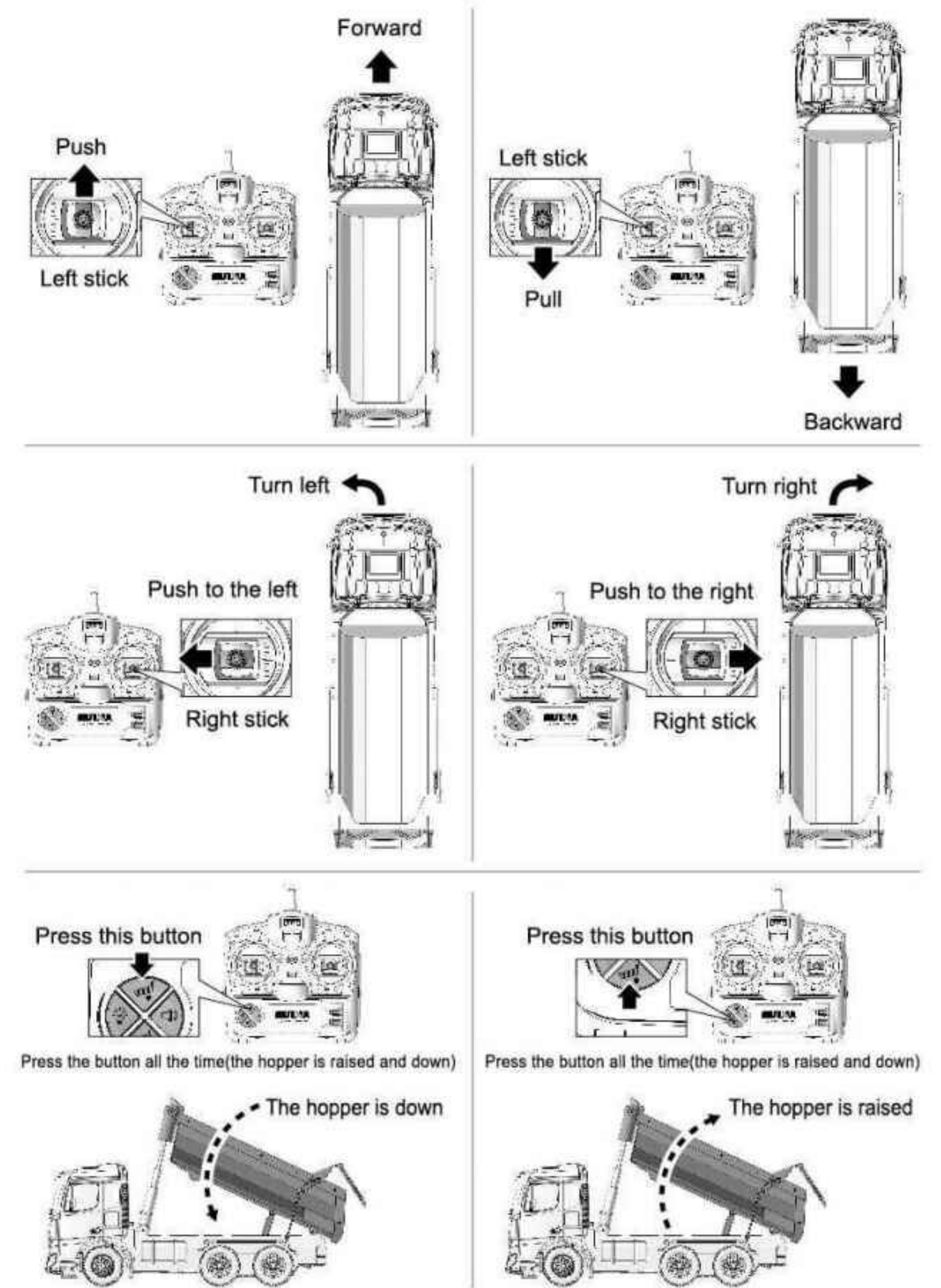

6 HUI NA MODEL

The match of R/C frequency and power on

This product is controlled by the frequency of 2.4GHz. When playing it at the first time, please turn on the power and wait for the automatically matching of frequency. The sound "beeps" given by the product indicates that the frequency is matched successfully.

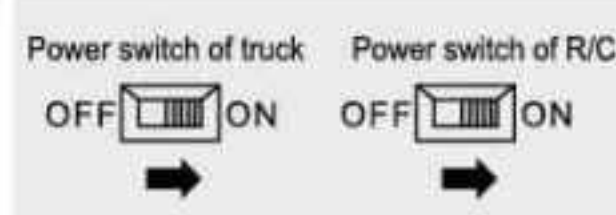

Control of light and sound

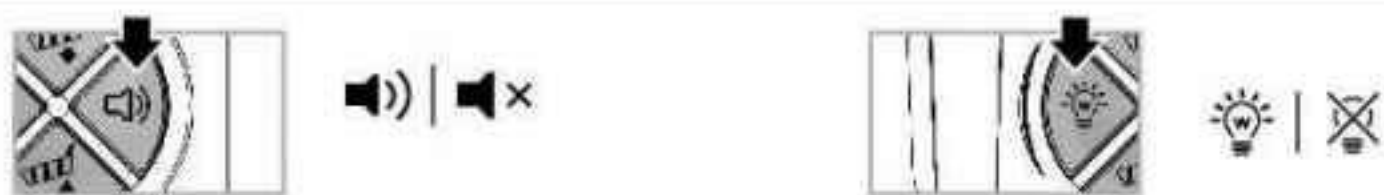

Press this button to turn on the sound, and press once more to turn it off.

Press this button to turn on the light, and press once more to turn it off.

The operation of front wheel

When the truck can't go straightly, please control the front wheel to the left or right lightly.

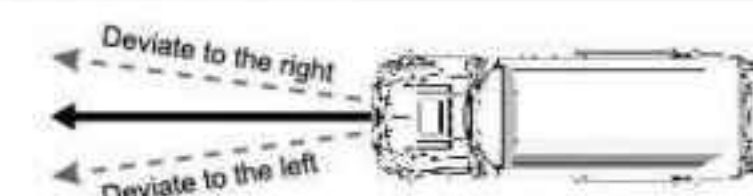

Rectification of deviation to the left

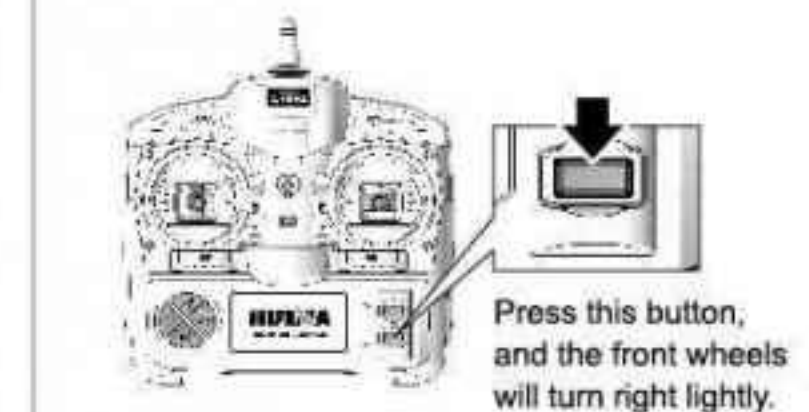
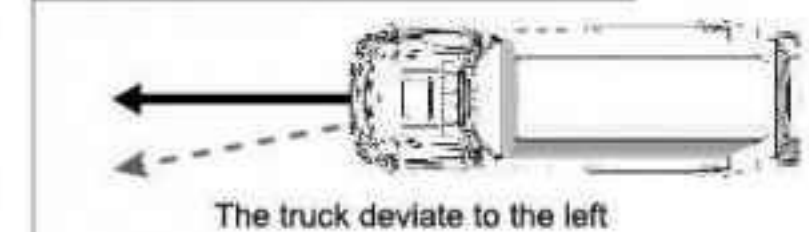

Rectification of deviation to the right

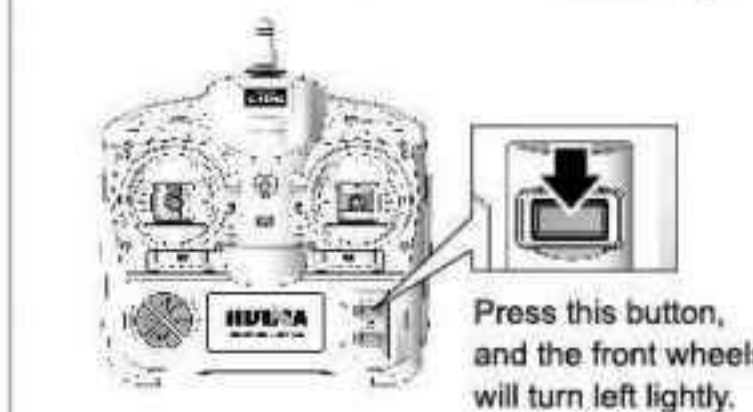

5 HUI NA MODEL

Installation of Remote Control Battery

- Loosen the screw of battery cover by screwdriver and take out battery cover. (Pic.1)
- Put four 1.5V AA non-rechargeable batteries (batteries need to be purchased separately) into the battery box to the right polarity at the bottom of remote control. (Pic.2)
- Install the battery cover and tighten the screw. (Pic.3)

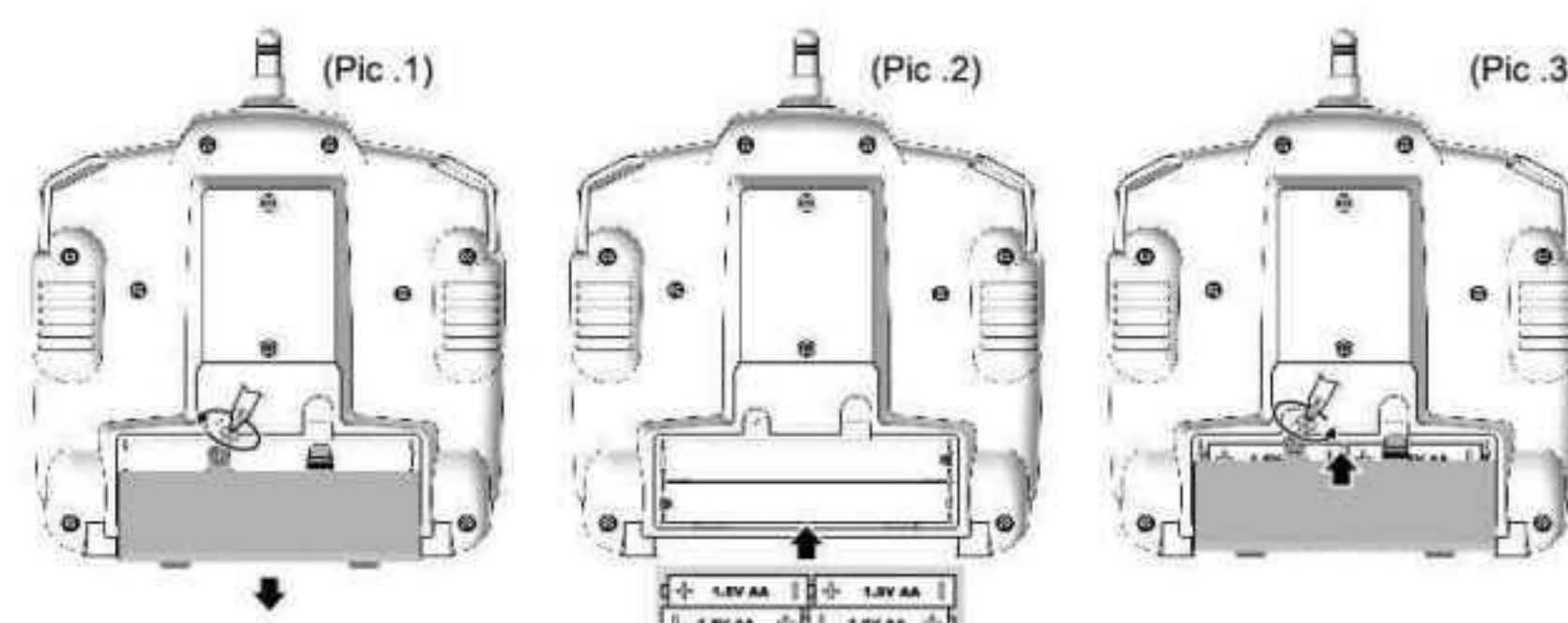

ATTENTION: Batteries shall be to the right polarity.

Battery Installation Instructions:

- Take out and install battery correctly.
- The non-rechargeable battery can't be charged.
- The rechargeable battery can only be charged under custody of adults;
- Different batteries or new and old batteries can't be used together;
- Battery of same model or recommended model can be used;
- The rechargeable battery should be taken out from model before charging.
- Battery should be placed with correct polarity;
- The exhausted battery should be taken out from model;
- Short-circuit of battery terminal is forbidden;

2 HUI NA MODEL

Installation of setting battery in truck

- Loosen screw of battery cover by screwdriver, twist the buckle and take out battery cover. (Pic.1)

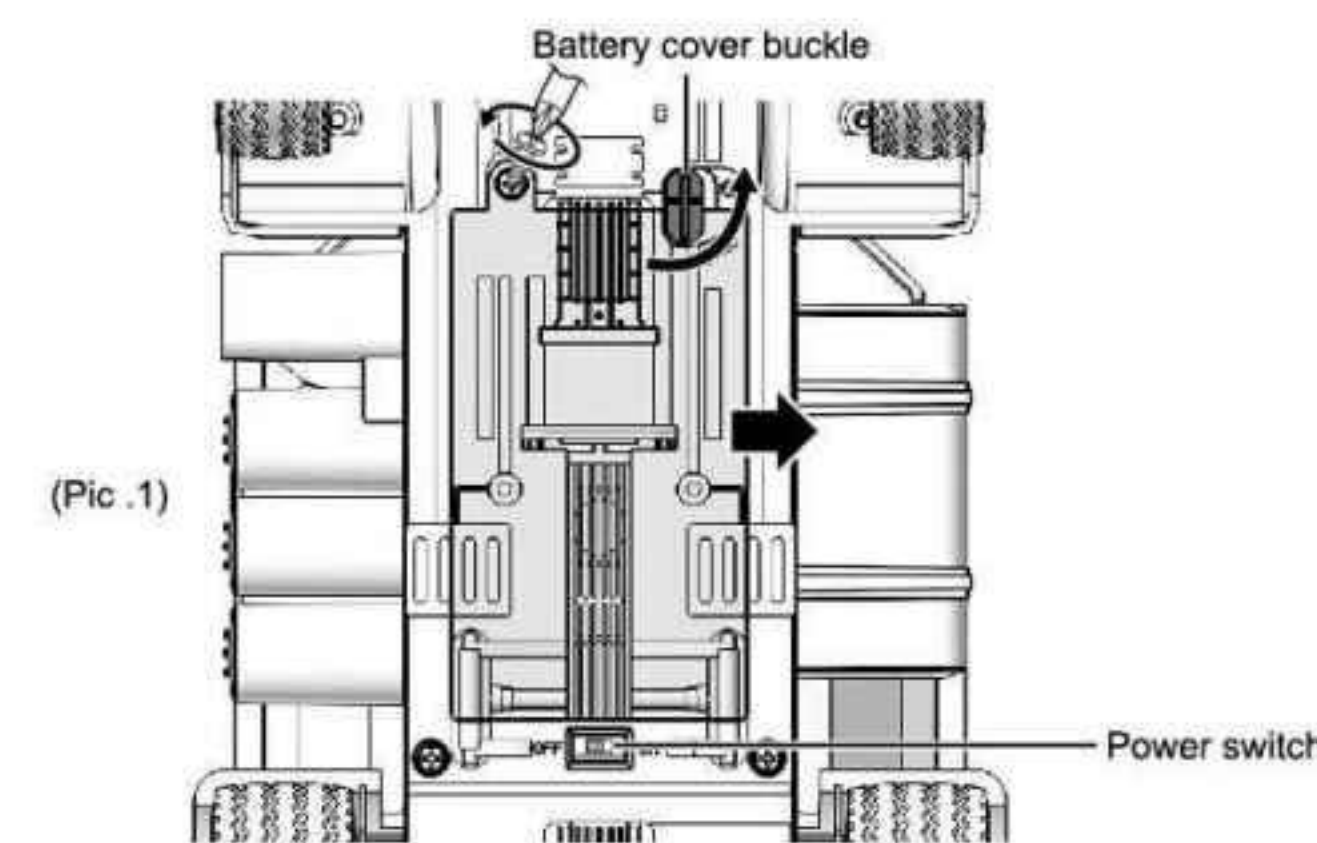

- Connect rechargeable battery with power port of truck, then put it into the battery box. (Pic.2)

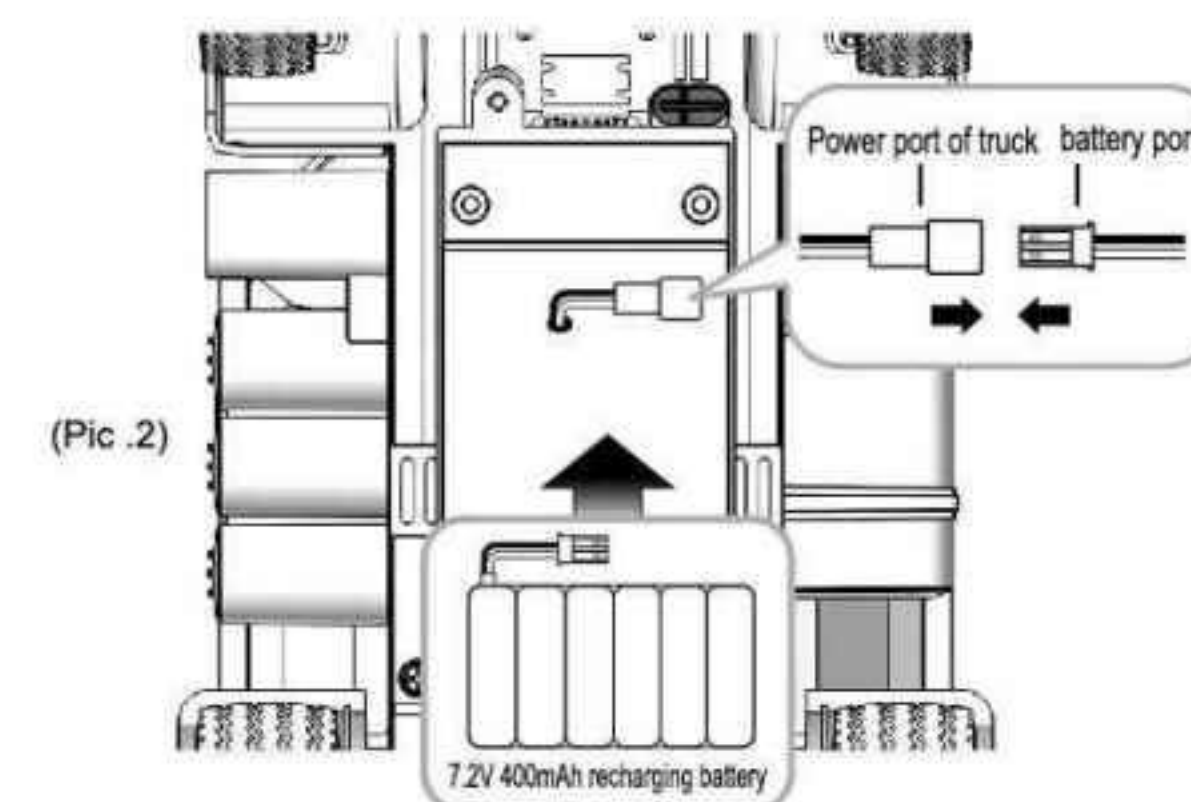

- Install the battery cover, tighten the screw and twist the buckle back. (Pic.3)

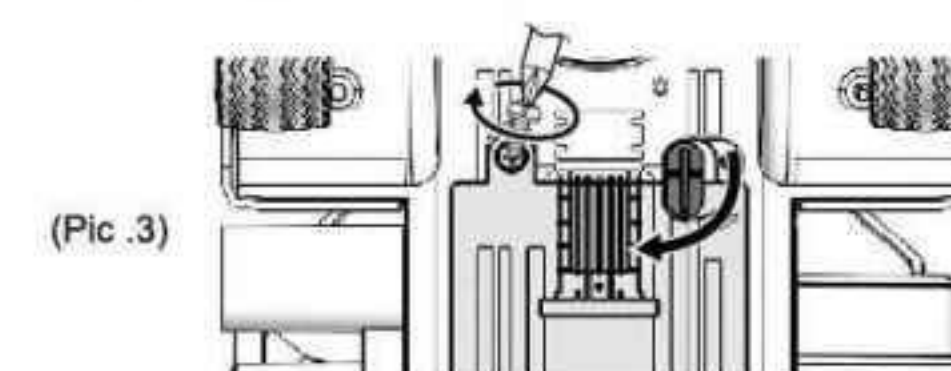

3 HUI NA MODEL

Battery charging instruction

Charging methods

Connect the battery port with USB charging port as the picture shows. Make sure the port be connected tightly and correctly. Then insert the USB charging plug into power adapter and perform charging.

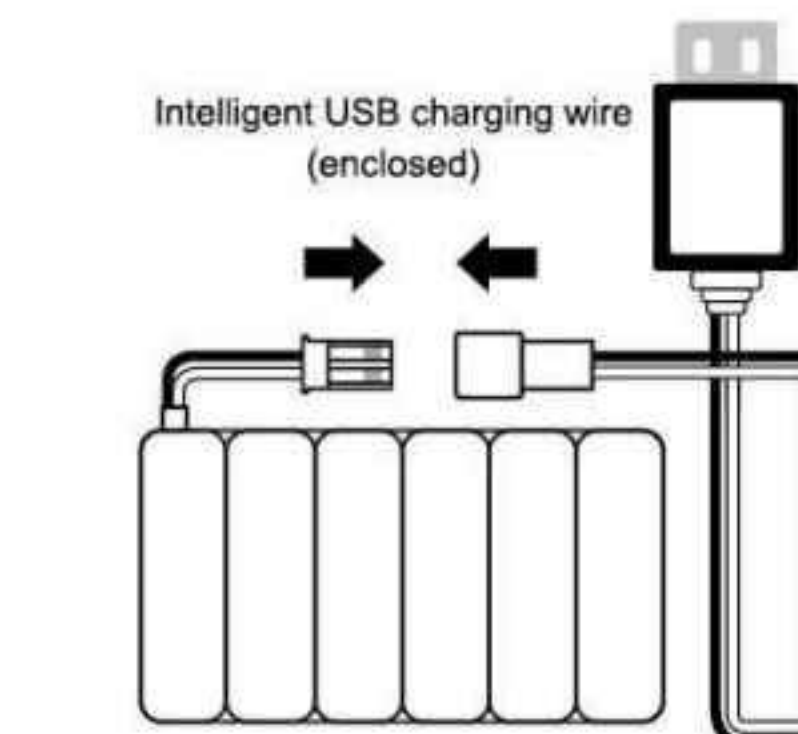

- State of USB light:
- The LED is lighting all the time when being connected.
 - The LED is flashing when charging.
 - The LED is off when battery is full of power.

Charging time: 3-4 hours
When the battery is full of power, please pull off USB wire in time.

7.2V 400mAh recharging battery

WARNING

- The truck is equipped with a set of 7.2V 400mAh batteries, and the remote control is equipped with 4 1.5V "AA" non-rechargeable batteries.
- Please install and dismantle battery in correct polarity and voltage. The battery shouldn't be short-circuited.
- Don't charge non-rechargeable batteries.
- Please charge rechargeable batteries under adults' custody.
- Please take out the rechargeable batteries from the product before charging.
- Different type of batteries shouldn't be used at the same time.
- Only batteries enclosed or recommended can be used.
- Batteries without power should be taken out from product. Please take out the batteries if the product isn't used for a long time.
- The power port shouldn't be short-circuited.
- The charging time is about 3-4 hours.
- Don't connect to power more than recommended.
- When using USB, please check if the wire, plug, shell and other parts are damaged or not. In case of any damage, don't use it till it's repaired well.

4 HUI NA MODEL